

Operating & Installation Guide

CURTAIN

Outdoor/Indoor
intrusion detector with
curtain field-of-view



MAXIMUM Security (1984) Ltd.

MAXIMUM HOUSE at Savoyon Junction
ISRAEL, Ono-Kiryat, Levy Eshkol Road 201
TEL. ++972-3-6349853 FAX. ++972-3-6349775
www.maximum.co.il

FEATURES

- Creates a super narrow protective screen of 3°.
- Combines PIR & Microwave technology.
- Masking protected (Anti-masking) by active infrared beams.
- Adjustable PIR detection sensitivity.
- Adjustable Microwave detection sensitivity.
- Selectable detection technology combination: AND/OR.
- Memory latched input.
- Extremely reliable & highly immune to false alarms.
- Auto temperature compensation.
- Automatic adaptation to background noise.
- A/D signal analyzer.
- Powerful microprocessor controlled.
- SPC - Smart Processing Controller.
- High level of RFI/EMI immunity.
- Two "Optomos" relays for lifetime operation.
- 90° Mounting bracket (provided).

CONGRATULATIONS

We thank you for choosing a product of **MAXIMUM Security (1984) LTD.** Based on over 25 years experience in R&D and in production of advanced security systems, we are proud to introduce to you the best Outdoor / Indoor motion detector ever presented, for industrial, commercial and residential security.

To ensure proper operation and maximum use of all its benefits, please read all parts of this installation and operating manual, and follow the step-by-step instructions.

INTRODUCTION

CURTAIN creates a super narrow protective screen of 3° (like a curtain) to secure openings and open fields against intruders. This type of protection allows free movement of people within the protected site- without setting off an alarm. **CURTAIN** is waterproof and can be installed outdoors or indoors.

In addition to an unprecedented amazing and reliable detection capability, **CURTAIN** is equipped with excellent protection against any attempt to disable its operation by blocking (masking) its near field-of-view, whether the alarm system is Armed or Disarmed (*Anti-masking protection*).

The protection against masking the near field-of-view of the detector is achieved by a continuous active infrared beams scan. **CURTAIN** will detect almost any type of material that blocks (masks) its near field-of-view. It will also detect transparent objects such as clear glass and plastic bags. It will activate an alert even if its lens was sprayed with paint or covered by a sticker.

CURTAIN combines two detection technologies- Microwave and Passive Infrared (PIR), and verifies any intrusion by both methods. An advanced and unique algorithm enables it to work in the most difficult environmental conditions and where high security is required, while maintaining unprecedented immunity to false alarms.

APPLICATION - 1

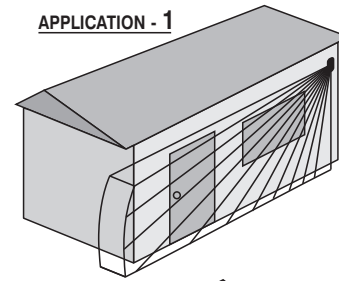

APPLICATION - 2

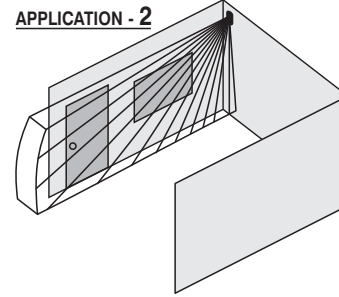

APPLICATION - 3

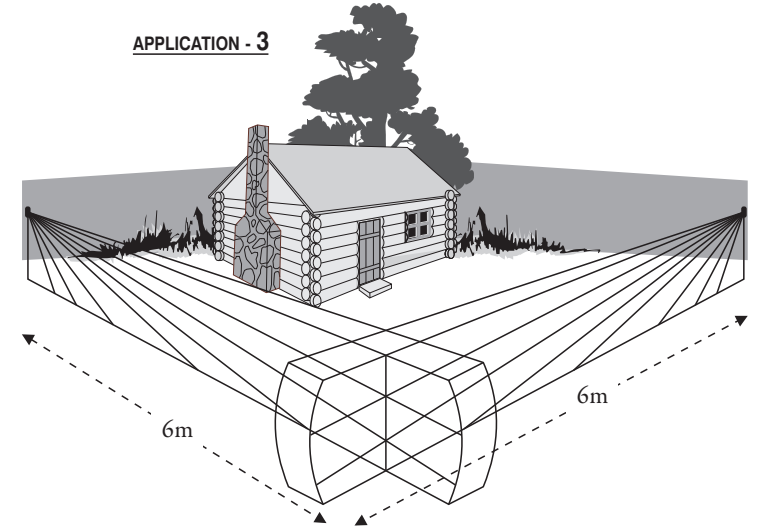

2

3

4

5

6

7

CRUCIAL NOTES

- At least one detector per open should be installed.
- The protected area must be protected by additional detection means and internal detectors.
- As all other products, this product can be cheated and defeated as well.
- This product, as any other, may go out of order or damaged during normal use or a result of vandalism.
- A full proper activity and performances of this product should be checked on a weekly basis by a person qualified by the manufacturer and received its written permission for that.

VIEW DIAGRAMS-OF-S FIELD'DETECTOR

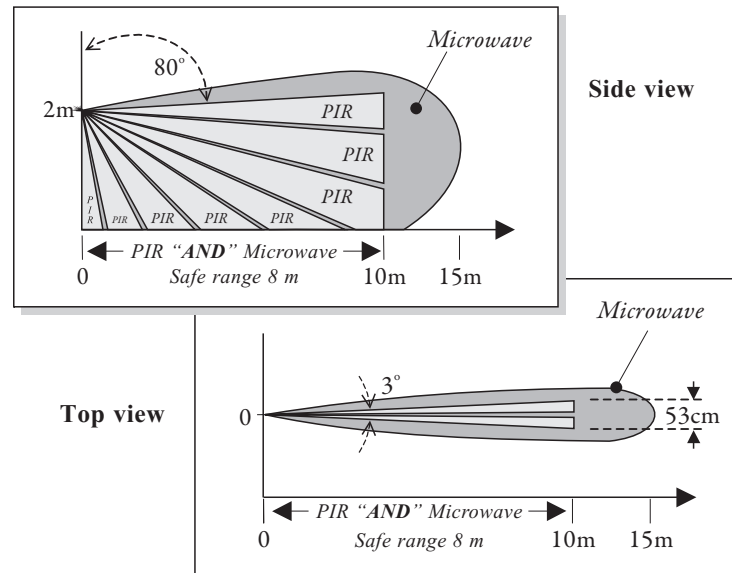

CURTAIN operates its relays and LED indicators according to the type of detection as follows:

TYPE OF DETECTION	LED INDICATORS	Remarks+ RELAY STATUS
Alarm- True motion detection	Red + Green Blinking simultaneously	ALARM relay will activate for 2 seconds.
R.I.P. Detection	Red	No relay will operate
Microwave detection	Green	No relay will operate
Anti-masking detection	Orange Blinking	If masking persists for more than 90 seconds, the orange LED will glow continuously, and the MASK relay will operate for at least 2 seconds and for as long as the masking exists

8

9

10

11

12

MOUNTING PROCESS OF CURTAIN USING ITS 90° MOUNTING BRACKET

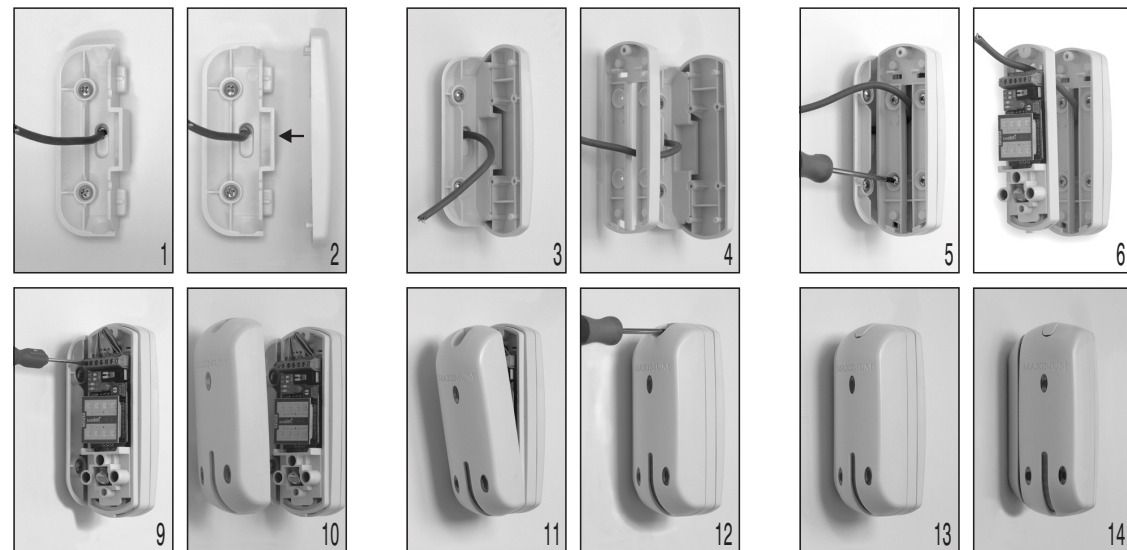

13

14

15

MOUNTING PROCESS OF CURTAIN WITHOUT USING ITS 90° MOUNTING BRACKET

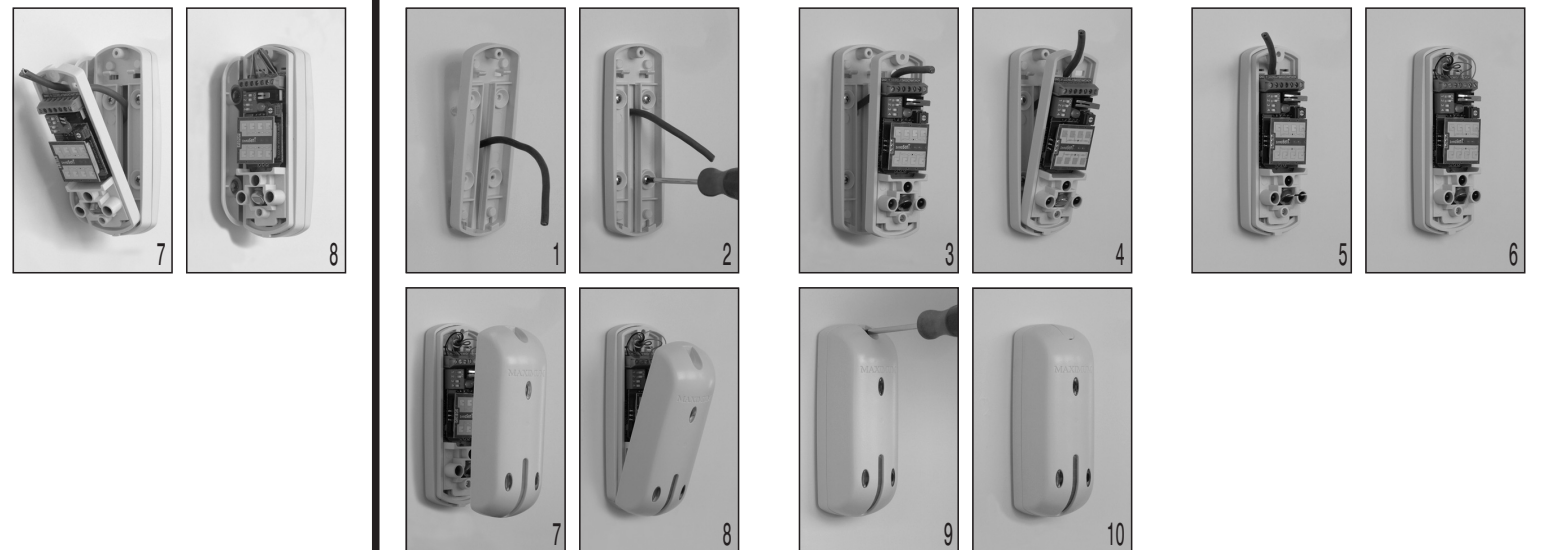

16

17

18

19

TERMINAL BLOCK WIRING

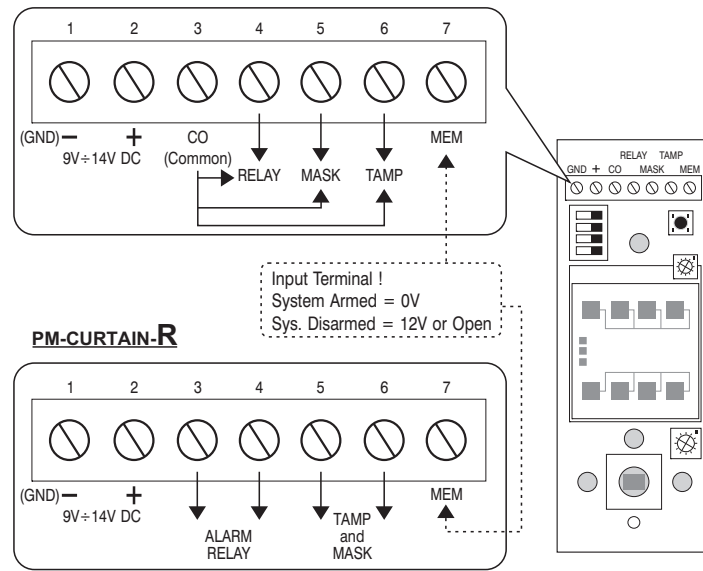

20

21

WIRING TERMINAL SPECIFICATIONS PM-for model CURTAIN

Terminal No. 1+2

Indicated on the circuit as: + -
These are the 9V to 14V DC power supply inputs.

Terminal No. 4 (with No. 3)

Indicated on the circuit as: **RELAY**
Represents the contacts of the "Alarm Relay", which are Normally in Closed state (N.C.). Upon detection of any human movement, the relay's contacts are opened for two seconds.

Terminal No. 5 (with No. 3)

Indicated on the circuit as: **MASK**
Represents the contacts of the "Anti-masking Relay" which are normally in closed state (N.C.). If an object blocks (masks) the detector's near field-of-view for more than 90 seconds, the contacts will open for at least 2 seconds and will remain open for as long as the masking exists.

22

Terminal No. 6 (with No. 3)

Indicated on the circuit as: **TAMP**
Represents the contacts of the built-in TAMPER switch, which are normally in a closed state (N.C.). The contacts will open, when the detector's case is opened.

Terminal No. 7

Indicated on the circuit as: **MEM**
This terminal is to be used if you wish to get a report from the detector's memory indicating if it has detected human movement during the armed period.

This terminal should receive an indication from the alarm system's control panel, whether it is in an Armed or Disarmed state.
- If 0V received, the detector "understands" that the alarm system is Armed.
- If 12V or no voltage at all received, the detector "understands" that the alarm system is Disarmed.

How to draw and display the detector's memory?
If: the detector was alerted during the "armed" period.

Then: upon switching the alarm system from "Armed" to "Disarmed" mode, the Red LED will be activated for 30 minutes.

23

WIRING TERMINAL SPECIFICATIONS for model CURTAIN-PM-R

The configuration of model CURTAIN-PM-R allows you to connect the TAMPER switch and Anti-masking outputs on the same line. In that case, you can use a cable of 1 wire less than you should use in a standard configuration.

Terminal No. 1+2

Indicated on the circuit as: + -
These are the 9V to 14V DC power supply inputs.

Terminal No. 3 + 4

Indicated on the circuit as: **RELAY**
Represent the contacts of the "Alarm Relay", which are Normally in Closed state (N.C.). Upon detection of any human movement, the relay's contacts are opened for two seconds.

Terminal No. 5 + 6

Indicated on the circuit as: **TAMP and MASK**
Represent the contacts of the "Anti-masking Relay" which are normally in closed state (N.C.). If an object blocks (masks) the detector's near field-of-view for more than 90 seconds, the contacts will open for at least 2 seconds and

24

will remain open for as long as the masking exists.

The same terminals represent the contacts of the TAMPER switch which are normally in closed state (N.C.). The contacts will open, when the detector's case is opened.

Terminal No. 7

Indicated on the circuit as: **MEM**
This terminal is to be used if you wish to get a report from the detector's memory indicating if it has detected human movement during the armed period.

This terminal should receive an indication from the alarm system's control panel, whether it is in an Armed or Disarmed state.
- If 0V received, the detector "understands" that the alarm system is Armed.
- If 12V or no voltage at all received, the detector "understands" that the alarm system is Disarmed.

How to draw and display the detector's memory?
If: the detector was alerted during the "armed" period.

Then: upon switching the alarm system from "Armed" to "Disarmed" mode, the Red LED will be activated for 30 minutes.

25

DETECTION SENSITIVITY ADJUSTMENT

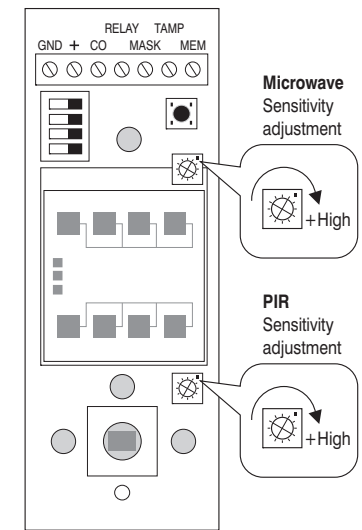

26

DIP SWITCH ADJUSTMENT

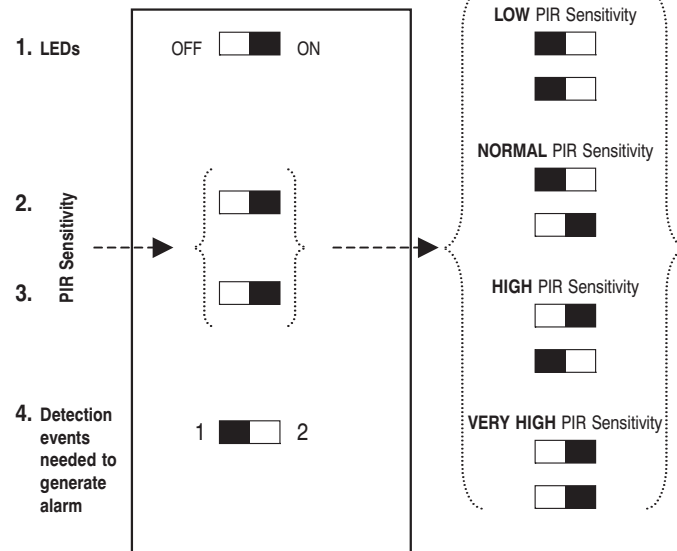

27

28

PREPARING THE MASKING CHANNEL FOR OPERATION (Obligatory for proper Anti-masking operation !!!)

To enable proper operation of the masking detection (Anti-masking), it is necessary to allow the detector to automatically study and analyze the environmental conditions of its protected area.
This is an obligatory action that should be performed by the installer, ensuring proper operation of the Anti-masking channel !!!

Study procedure to be performed in two cases:

- Upon connecting the power supply to the detector (after about 1 minute, the time it takes the detector to stabilize when first fed by power supply).
- Upon the position of DIP switch number-1 (LED indicator) is changed.

29

Study procedure:

- Immediately close the detector's case (within 15 seconds maximum).

- Keep at least 1 meter away from its front part, until the study procedure is complete, about 1 minute.

LED indication during the study procedure:

- The Red+Green LEDs blink rapidly for about 30 seconds.
- A break of about 20 seconds (none of the LEDs are activated).
- The Red+Green LEDs blink rapidly for about 10 seconds.

PERFORM A TEST

To be carried out when the case is closed and the LEDs are enabled (DIP switch No.1 switched to ON).

30

Test procedure for human movement detection (Alarm):

- Walk in the protected area.

Compulsory reaction of the detector:
Upon each detection, the "Alarm Relay" will operate for 2 seconds.
The Red+Green LED indicators will blink simultaneously during those 2 seconds.

Test procedure for masking detection (Anti-masking):

- At a distance of about 10 cm from the front of the detector, place a white piece of paper (or any other object).
- Compulsory reaction of the detector:
The Green LED will immediately blink continuously as long as the masking object exists. If the masking object exists for more than 90 seconds, the orange LED will glow continuously and the "MASK" (Anti-masking) relay will operate for at least 2 seconds and for as long as masking exists.

31

SPECIFICATIONS

- Power supply 9 to 14V DC
- Current drain Standby: 20mA (Max.); Operation: 30 mA (Max.)
- Alarm relay contacts endurance 15V DC / 20 mA
- Anti-masking relay contacts endurance 15V DC / 20 mA
- TAMPER Switch endurance 24V DC / 0.1A
- Warm-up time 1 Minute
- Alarm period 2 Seconds
- Anti-masking relay respond time 90 Seconds (Max.)
- Anti-masking relay activation period All time of masking (at least 2 seconds)
- Motion detection coverage 10 meter, 3°
- Operating Temperature (-)37 ~ (+)70°C
- Microwave operating Frequency 24.125 GHz

32

CERTIFICATE OF WARRANTY

MAXIMUM Electronics (1984) Security Ltd. thanks you for buying its products, which have proven their reliability and effectiveness over many years.

To ensure proper operation and functioning of the product and benefit from its features to the utmost, read the Installation & Operating instructions carefully and follow them step by step.

MAXIMUM Electronics Security (1984) Ltd. (hereinafter – the "Manufacturer") hereby warrants/guarantees the products manufactured by it (hereinafter – "Product" or "Products") against defects in production or in materials discovered during their reasonable use and servicing, in accordance with the Manufacturer's instructions, recommendations and limitations and subject to the provisions of this Certificate of Warranty.

This Warranty is for a limited period of 12 months from the last day of the week and the year whose number is printed on the electronic card (PCB) and/or electronically encoded in one of the Product's components.

33

This Warranty is limited to the repair of a defective Product, or its replacement at the Manufacturer's option, during the Warranty period, subject to reasonable use and servicing in accordance with the Manufacturer's instructions, recommendations and limitations.

To realize the Warranty rights, the Product must be sent to the Manufacturer securely packaged and accompanied by a document describing the problem, with insurance and freight prepaid by the sender.

The Manufacturer's products boast a high standard of reliability, proven in tens of thousands of products over many years. The percentage of problems encountered in them is virtually nil, therefore a Product must be carefully checked (according to the operating instructions) before sending it to the Manufacturer for examination and/or servicing in the Warranty framework.

In the event that the installer and/or user and/or customer and/or operator of a Product

34

(hereinafter – the "Customer") returned the Product to the Manufacturer on the grounds that it is defective and received in exchange from the Manufacturer a functional product, and upon examination the Manufacturer found that the returned Product was not defective – the Customer will be charged the Product's full value as consideration for the resources invested by the Manufacturer in its examination.

The Manufacturer shall in no case be liable for damage or loss (including monetary loss), whether direct, indirect, accidental, circumstantial or otherwise, entailed in the dismantling or reinstallation of the Product.

In case the Manufacturer decides to replace a returned Product that was found to be defective, the Customer hereby gives its consent to receiving – at no added cost – also a higher version of the Product.

This Warranty is not valid in the following cases: incorrect installation, installation and/or operation not in accordance with the Manufacturer's instructions, alteration, misuse,

35

accident, sabotage, repair or servicing by someone other than the Manufacturer.

The Customer must take all necessary precautions to prevent and eliminate any discharge of static electricity or other interference that could affect the Product's functioning.

This Warranty is exclusive and explicit and replaces any other warranty, commitment or guarantee – whether written, oral or implied. The Manufacturer will in no case be liable toward anyone for a breach of this Certificate of Warranty or of any of its foregoing provisions.

This Certificate of Warranty may not be altered, exchanged or expanded, and the Manufacturer does not authorize anyone to do so on its behalf – including any distributor, dealer, agent, representative or employee of the Manufacturer operating by its authority or on assignment from it.

This Warranty applies to the Product only! Any other product, accessory or adjunct used

36

together with the Product (including batteries) will be covered solely by its exclusive warranty, if such exists.

The Manufacturer shall in no case be liable for damage or loss, whether direct, indirect, accidental, circumstantial or otherwise, caused by the proper and/or improper functioning of the Product due to use of other products, accessories or adjuncts (including batteries) together with the Product.

The Manufacturer does not claim that the Product is immune to malicious neutralization, bypass, sabotage or deception, or that it will prevent in every case death or physical and/or mental injury due to burglary, robbery, fire or the like, or that the Product will provide in all cases adequate and/or suitable warning or protection.

The Customer understands that correct installation and maintenance, in accordance with the Manufacturer's instructions, recommendations and limitations, merely reduces the risk of failure to give warning in

37

cases such as burglary, robbery and fire, but in no way ensures or guarantees that such cases will not occur or will not result in death or physical and/or mental injury and/or damage to property.

The Manufacturer shall in no case be liable for death or physical and/or mental injury and/or damage to property and/or loss of any kind, whether direct, indirect, accidental, circumstantial or otherwise, on the grounds that the Product did not operate/function properly and/or as expected and/or according to the description in its specification or in any other documentation.

The Manufacturer shall in no case be liable for damage or loss (including death or physical and/or mental injury and/or damage to property), whether direct, indirect, accidental, circumstantial or otherwise, caused through use of and/or reliance upon the Product. In the event that the Manufacturer is held liable, directly, indirectly, circumstantially or otherwise, for any loss or damage according to the terms of this limited Warranty or otherwise (irrespective of its cause or origin),

38

the maximum amount of the Manufacturer's warranty and/or guarantee shall not exceed in any case the Product's price, and it shall be payable as full and final consideration, and not as a penalty, and shall constitute the entire and sole compensation by the Manufacturer.

It is hereby clarified that the Warranty under this Certificate of Warranty does not cover anything not explicitly and specifically referred to herein.

It is hereby agreed that the Customer waives in advance any claim or contention against the Manufacturer. Should the Customer and/or a person on his/her behalf nevertheless file suit against the Manufacturer, the Customer and/or that person in such case shall bear all their costs and the Manufacturer's costs arising therefrom, including lawyer's fees, and shall indemnify the Manufacturer for the full amount adjudicated against it in a decision, if any, rendered by any court or arbitrator.

39

Warning!

The Customer must make sure that the Product meets all his/her requirements, and he/she must comply fully with the installation and operating instructions and *inter alia* check the Product and the entire system at least once a week including under field conditions.

For various reasons (but not only those set out below), changes in environmental conditions and/or electric or electronic interference and/or malicious damage to the Product could cause the Product to function in an unforeseen manner.

The Customer must take all precautions to ensure his/her own safety and security and that of his/her property.

The Customer confirms that he/she read all the conditions of this Certificate of Warranty and he/she agrees thereto. Installation and/or operation of the Product shall be deemed as the Customer's agreement to all the conditions of this Certificate of Warranty.

40